

PURCHASE REQUEST

Entity Name: DENR Camarines Sur

Fund Cluster: 101

Office/Division : PENRO Cam Sur		PR No.: <u>2023-03-029 W</u>			Date: <u>8/9/2023</u>	
Section/Unit: CDS		Responsibility Center Code : <u>35</u>				
Property/Stock No.	Unit	ITEM DESCRIPTION		Volume (cu.m)	Unit Cost	Total Cost
		CONSTRUCTION OF SMALL WATER IMPOUNDING SYSTEM (SWIS)- SPRING DEVELOPMENT PROJECT IN THE PROVINCE OF CAMARINES SUR FOR CY 2023				
	1	LOT I	Construction of Spring Box and Storage Tank Location: Banga, Tinambac, Camarines Sur	13.00	73,250.00	952,250.00
	1	LOT II	Construction of Spring Box and Storage Tank Location: Tamban, Tinambac, Camarines Sur	13.00	73,250.00	952,250.00
	1	LOT III	Construction of Spring Box and Storage Tank Location: Bagoladio, Bula, Camarines Sur	12.00	73,250.00	879,000.00
	1	LOT IV	Construction of Spring Box and Storage Tank Location: Genorangan, Lagonoy, Camarines Sur	13.00	73,250.00	952,250.00
	1	LOT V	Construction of Spring Box and Storage Tank Location: Bataan, Tinambac, Camarines Sur	13.00	73,250.00	952,250.00
	1	LOT VI	Construction of Spring Box and Storage Tank Location: Laganac, Balatan, Camarines Sur	12.00	73,250.00	879,000.00
	1	LOT VII	Construction of Spring Box and Storage Tank Location: Cayocog, Balatan, Camarines Sur	12.00	73,250.00	879,000.00
	1	LOT VIII	Construction of Spring Box and Storage Tank Location: Lobong, Bato, Camarines Sur	12.00	73,250.00	879,000.00
	1	LOT IX	Construction of Spring Box and Storage Tank Location: Gatbo, Ocampo, Camarines Sur	12.00	73,250.00	879,000.00
	1	LOT X	Construction of Spring Box and Storage Tank Location: So. Bahi, San Jose, Lupi, Camarines Sur	13.00	73,250.00	952,250.00
	1	LOT XI	Construction of Spring Box and Storage Tank Location: Amomokpok, Ragay, Camarines Sur	12.00	73,250.00	879,000.00
	1	LOT XII	Construction of Spring Box and Storage Tank Location: Napolidan, Lupi, Camarines Sur	13.00	73,250.00	952,250.00
TOTAL	12			150.00		10,987,500.00
Purpose: For the construction of Small Water Impounding System (SWIS)-Spring Development Project in the Province of Camarines Sur for CY 2023						
Requested by:			Approved by:			
Signature : 						
Printed Name : <u>ALEJANDRO D. MARANAN</u>			RONNEL B. ASTOR			
Designation : OIC Chief, TSD			PENR Officer			
Funds Available:			ORS No. _____			
ANGELI MARTIN A. RUTAQUIO Budget Officer			Amount: <u>₱ 10,987,500.00</u> <u>SR2023-02-000001</u>			

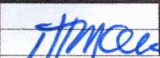
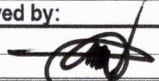

Republic of the Philippines
Department of Environment and Natural Resources
Provincial Environment and Natural Resources Office
Panganiban Drive, Naga City
Tel. No. (054) 811-0530
Email: penro_camsur@yahoo.com.ph

TERMS OF REFERENCE

Construction of Small Water Impounding System (SWIS)-Spring Development Project in the Province of Camarines Sur

A. Rationale

The Small Water Impounding System (SWIS) will serve as source of stable water even during dry season for agricultural and domestic use of communities and to ensure sustainable water supply for the management and maintenance of ENGP established plantations, stabilize soil condition and aids in mitigating the impacts of flooding and soil erosion. The SWIS is one of the small-scale technologies developed by Bureau of Soils and Water Management (BSWM). These structures are made to harvest and store rainfall and runoff such as the construction of spring boxes and storage tanks for multiple and immediate uses.

B. Project Cost : ₱ 10,987,500.00 / ₱ 73,250.00/cu. m

C. Volume : 150 cu. m

D. Funding : Regular Agency Fund – SAA No. SR2023-02-000001

E. Scope of Work

1. The structure consists of Spring Box, Rectangular Concrete Tank, Delivery Pipe, and Distribution Pipe.
2. The construction shall conform to the shape, lines, and dimensions shown on the approved detailed engineering design and program of works and its specifications. They shall be substantial and designed to resist the pressure and weight of the concrete;
3. The spring water shall be free of sediments and other foreign matter;
4. That to achieve watertight joints between GI pipe and fittings, teflon tape should be used around the threaded ends of GI Pipes, fittings or accessories;
5. That the components of the pipe network composed of 60 LM HDPE Pipe with 2 ½” diameter with total length of 180 LM to water tank and with ½” (9 cu.m.) and 2” (10 to 13 cu.m.) diameter of a total length of 800 mts. SDR 11 for delivery and distribution pipes shall be noncorrosive and non-scaling. Both PE pipe connections of delivery and distribution pipe must be connected using compression coupling and adaptor

6. All the surface of the spring and intake box will be plastered/finished with 1:2 Portland Cement mortar mixed. This is required to provide even dense surface of uniform color, free from marks, aggregate, pockets, honeycomb, or other imperfections;
7. Additional materials, if any in pipe and compression fittings paint, etc. will be directly charged to Overhead, Contingencies & Miscellaneous (O.C.M.-15% of DC) which amount is consolidated in the Cost and number of materials indicated in the Bill of Quantities; and
8. The construction of SWIS includes the following activities, such as:
 - Billboard with size of 2.00 m x 1.20 m shall be installed at a strategic place within the vicinity of the project sites (Annex A).
 - Site Works includes excavation, backfill, installation of delivery pipe, construction of spring and storage tank, and installation of distribution pipes.
 - Reinforced Concrete will use Class A (1:2:4) concrete mixture and standard 12mm, 16mm, and 10mm deformed steel bars as specified in the approved detailed plan and program of works.
 - Finishing and Plastering using Portland Cement mortar mixed.
 - All plumbing materials (pipes and accessories) to be used shall be in accordance with the plan, and specifications, and program of works.
 - The complete spring box shall be connected to a reinforced concrete water storage with a high-density polyethylene (HDPE) delivery pipe and from the water storage tank to the service area if site with a polyethylene (PE) distribution pipe.
 - Delivery pipes and all distribution pipes shall be buried in the soil except for the portion of lateral pipes where the emitters are located.
 - Installation of emitters in the lateral walls of the pipe.
 - Painting of the surface with white color. The logo and name of DENR PENRO Camarines Sur, Name of the Project and Storage Tank Capacity shall be painted in the surface where it can be easy to see (Annex A).

F. Project Duration : 60 days

G. Terms and Condition

1. Upon approval of the Contract and issuance of the Notice to Proceed, the winning bidder shall immediately commence the activities indicated in the Approved Program of Works and Design in coordination with DENR and the concerned Local Government Units (Municipality and Barangay). The coordination shall be documented and shall form part of the accomplished report.
2. The Contractor shall document and maintain records of activities performed and be made available at all times to the DENR Staff.
3. The Contractor shall submit accomplishment report with photo documentation (geotagged photos) to DENR.
4. Regular Monitoring of the project activities shall be conducted by the technical personnel of the DENR to ensure that all activities are in accordance with the Approved Program of Works and Design.

5. The DENR Composite Inspection Team (CIT) shall conduct an inspection of the accomplished activities upon receipt of the request for inspection and accomplishment report. The CIT shall recommend payment corresponding to the activities accomplished.

H. Payment of Contract Price

Payment of the contract price to the Contractor is based on the actual activities accomplished (progress billing) as validated by the Composite Inspection Team. Ten percent (10%) of the contract price shall be deducted for every billing as a retention fee which will only be released to the Contractor after the project is turned over and accepted by the DENR.

I. Penalty

The DENR shall charge the Contractor with liquidated damages in the amount equivalent to one-tenth (1/10) of one percent (1%) of the cost of the unperformed portion for every day of delay. Once the cumulative liquidated damages reach ten percent (10%) of the amount of the contract, the DENR shall rescind the contract without prejudice to the courses of action and remedies open to it (Sec. 28 Rule XXII of the Revised IRR of RA 9184).

Prepared by:

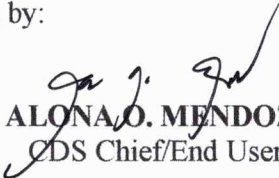

ALONA O. MENDOZA
CDS Chief/End User

Recommending Approval:

ALEJANDRO D. MARANAN
OIC, TSD

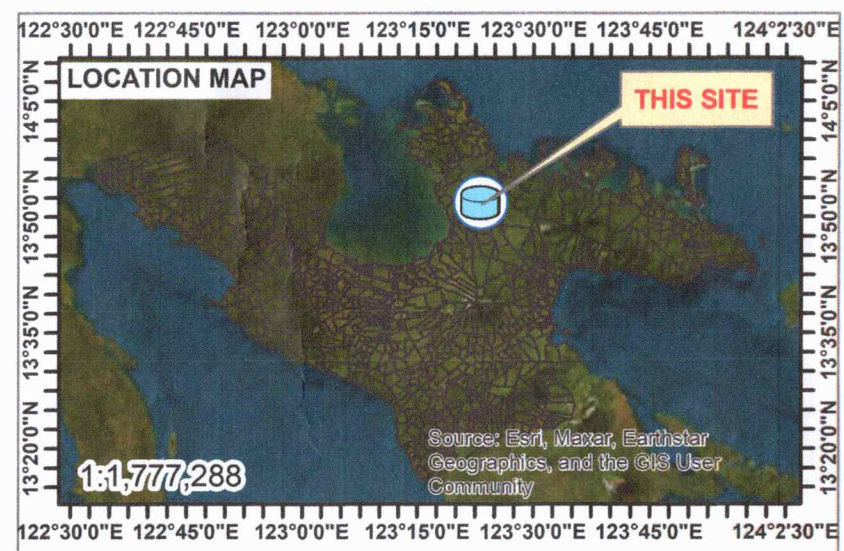
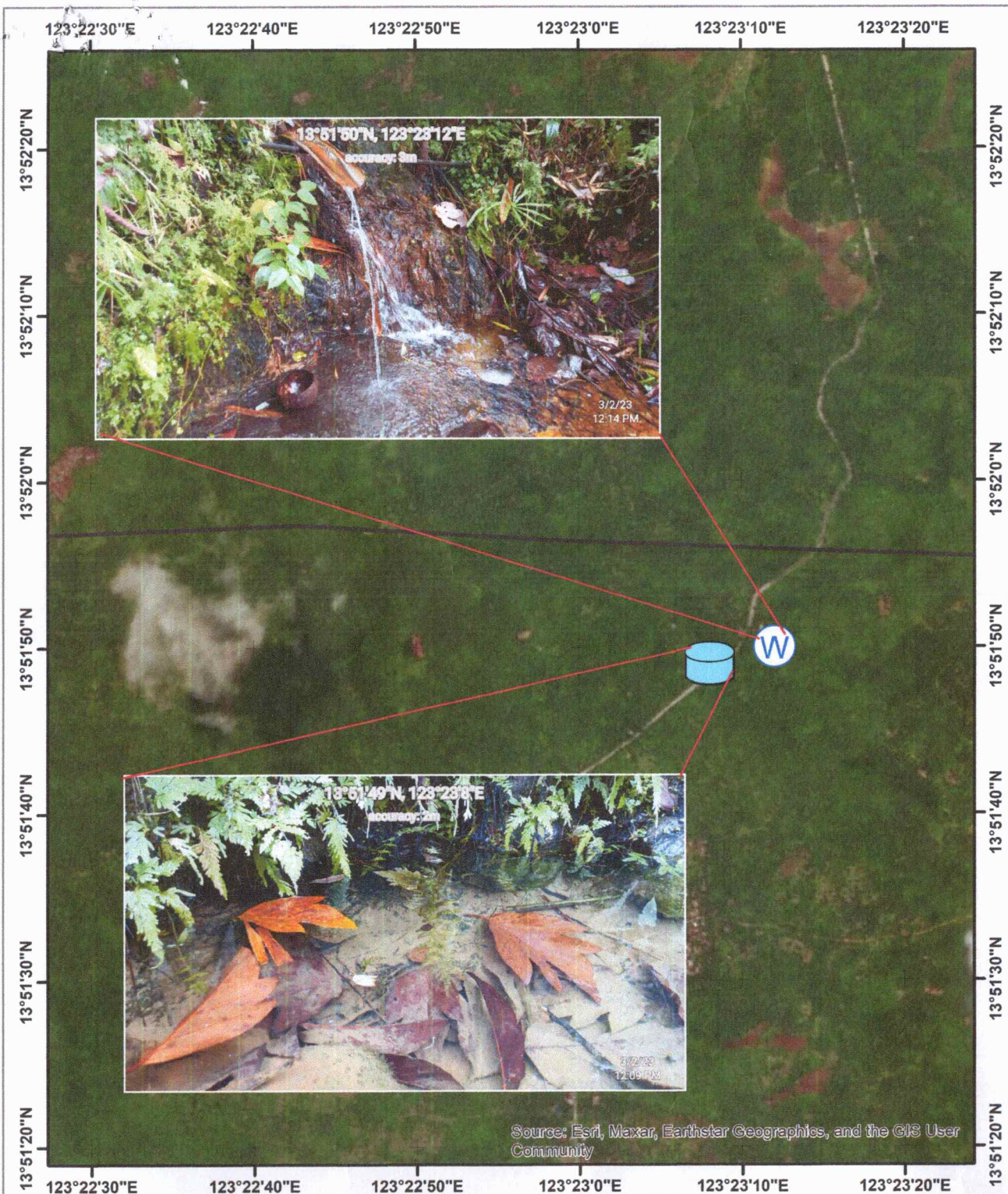

Approved by:

RONNEL B. ASTOR
PENR Officer





Proposed 13 cu.m Small Water Impounding System (Lot 1)
CY 2023
 Location : Barangay : Banga
 Municipality : Tinambac
 Province : Camarines Sur

0 70 140
 Kilometers

- Legend**
-  Storage Tank
 -  Water Source
 -  Barangay selection

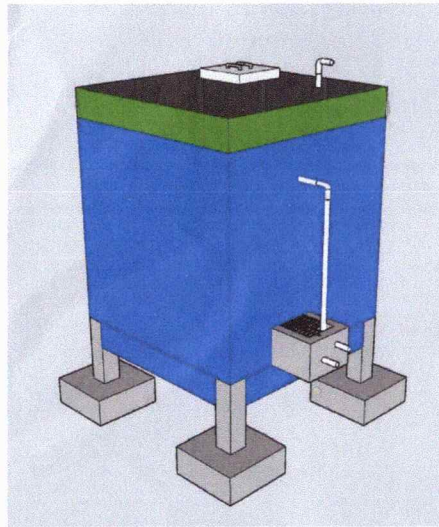
REPUBLIC OF THE PHILIPPINES
DEPARTMENT OF ENVIRONMENT AND NATURAL RESOURCES
PENRO CAMARINES SUR
CONSERVATION DEVELOPMENT SECTION



PERSPECTIVE VIEW

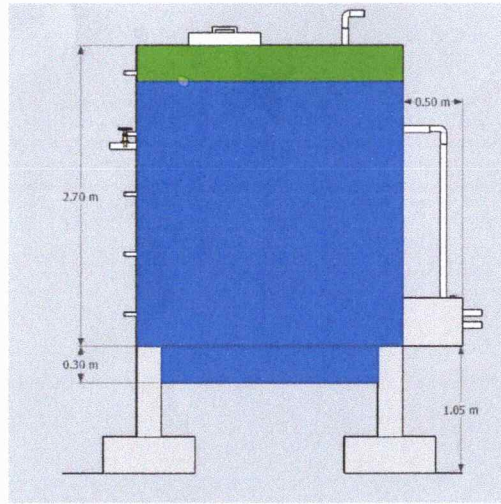

FRONT VIEW

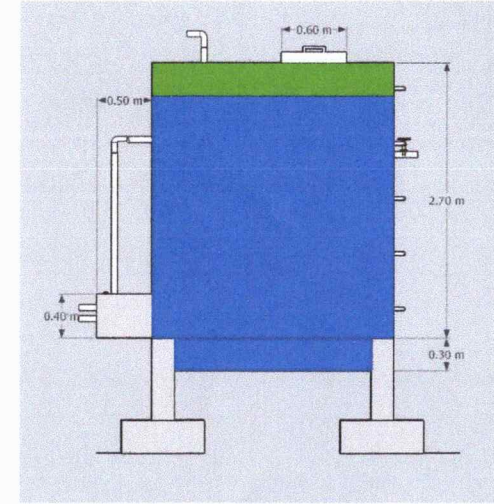

REAR VIEW

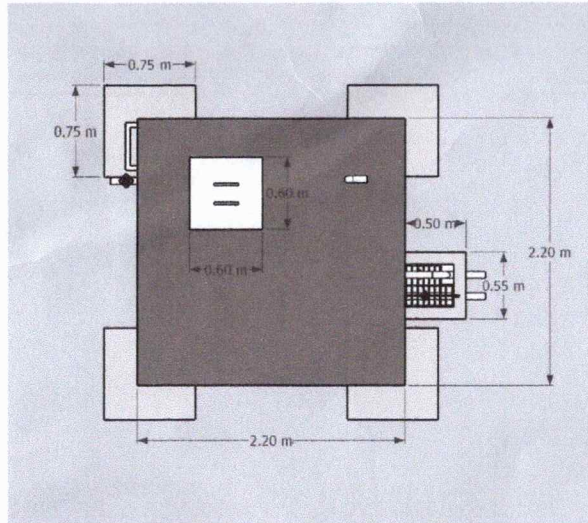

TOP VIEW

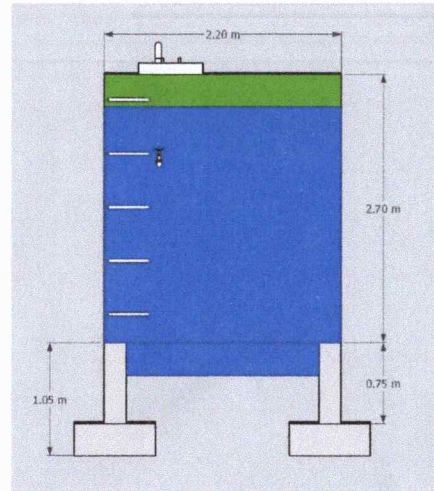

LEFT VIEW

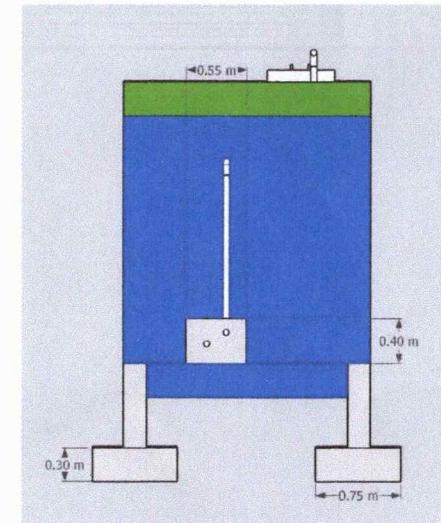

RIGHT VIEW

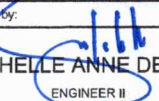

Prepared by:

NELCHELLE ANNE DE GUZMAN
 ENGINEER II

TITLE
**PROPOSED SMALL WATER IMPOUNDING SYSTEM (SWIS)
 (CONCRETE WATER TANK)**
 BRGY. BANGA, TINAMBAC, CAMARINES SUR

VOLUME
13 CUBIC METER

RECOMMENDING APPROVAL BY:

ALEJANDRO D. MARANAN
 OIC, TSD Chief

APPROVED BY:

RONNEL B. ASTOR
 PENR OFFICER

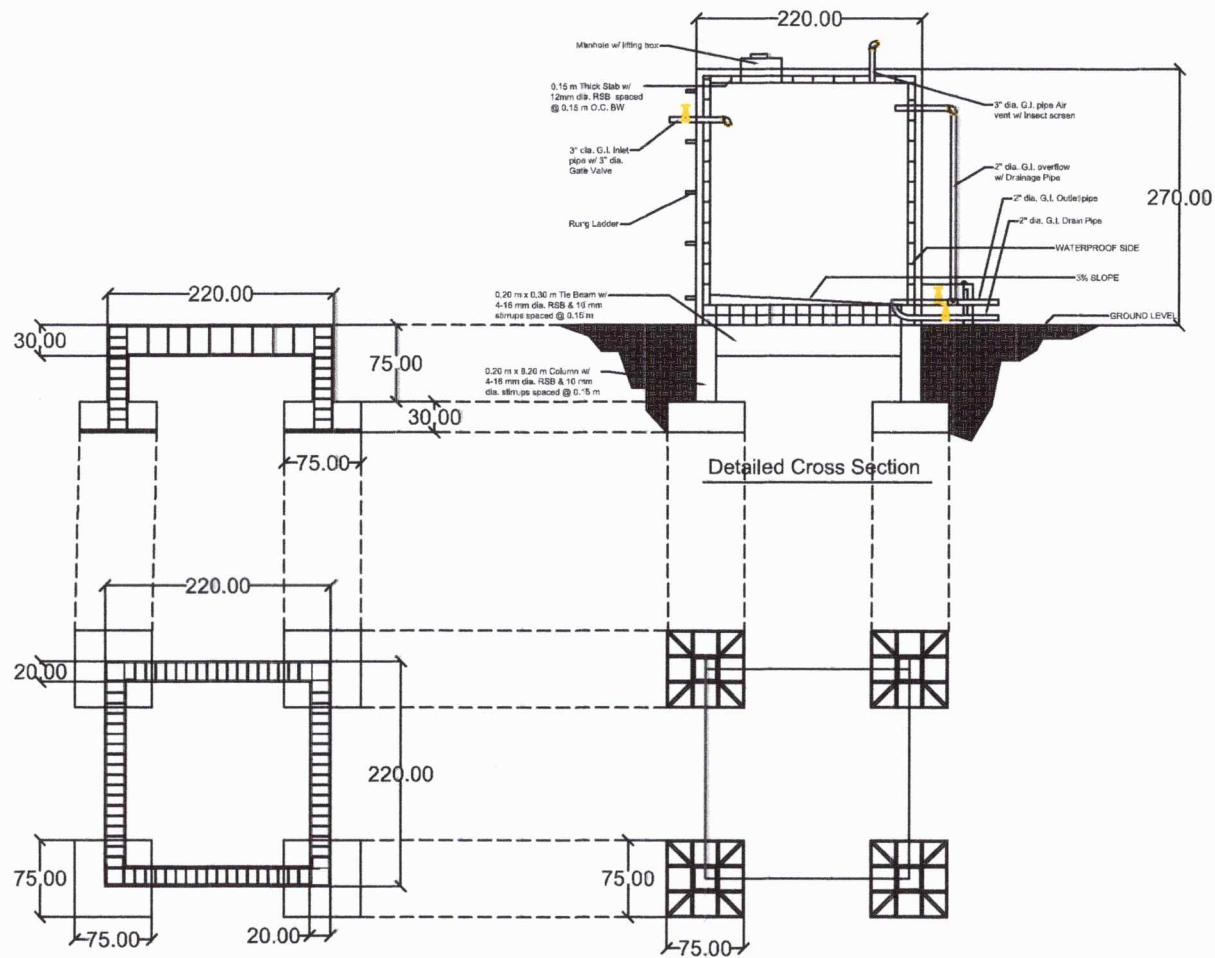
SHEET NO.

1
4



DETAILED SECTION OF COL./FOOTING



Prepared by: *[Signature]*
NELCHELLE ANNE DE GUZMAN
 ENGINEER II

TITLE
**PROPOSED SMALL WATER IMPOUNDING SYSTEM (SWIS)
 (CONCRETE WATER TANK)**
 BRGY. BANGA, TINAMBAC, CAMARINES SUR

VOLUME
13 CUBIC METER



RECOMMENDING APPROVAL BY:
[Signature]
ALEJANDRO D. MARANAN
 OIC, TSD Chief

APPROVED BY: *[Signature]*
RONNEL B. ASTOR
 PENR OFFICER

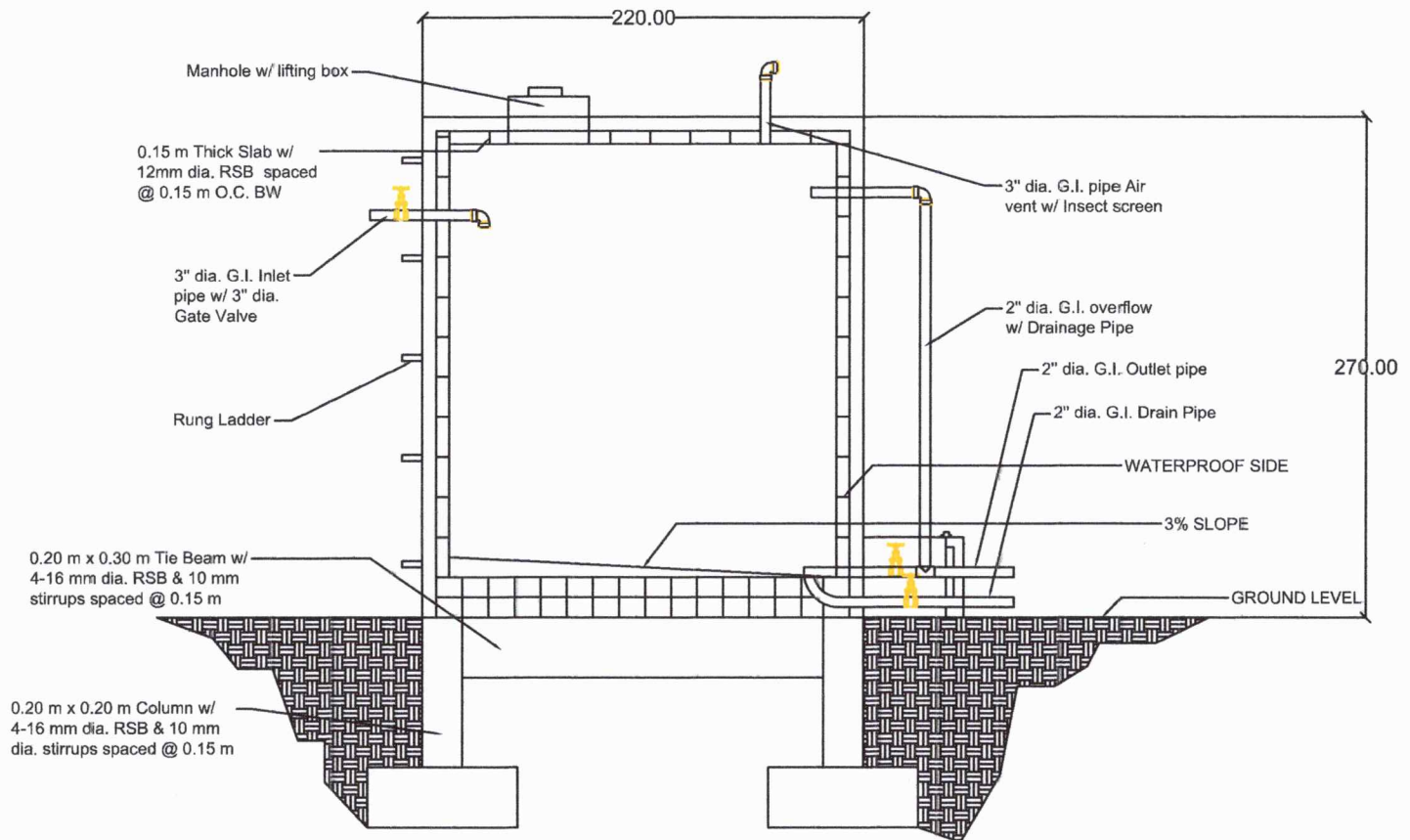
SHEET NO.
 2
 4

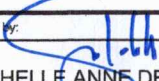
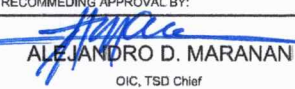

Detailed Cross Section

	Prepared by:  NELCHELLE ANNE DE GUZMAN ENGINEER II	TITLE PROPOSED SMALL WATER IMPOUNDING SYSTEM (SWIS) (CONCRETE WATER TANK) BRGY. BANGA, TINAMBAC, CAMARINES SUR	VOLUME 13 CUBIC METER	RECOMMENDING APPROVAL BY:  ALEJANDRO D. MARANAN OIC, TSD Chief	APPROVED BY:  RONNEL B. ASTOR PENR OFFICER	SHEET NO. <div style="border: 1px solid black; border-radius: 50%; width: 30px; height: 30px; margin: 0 auto; display: flex; flex-direction: column; align-items: center; justify-content: center;"> 3 4 </div>
---	---	--	---------------------------------	---	---	--

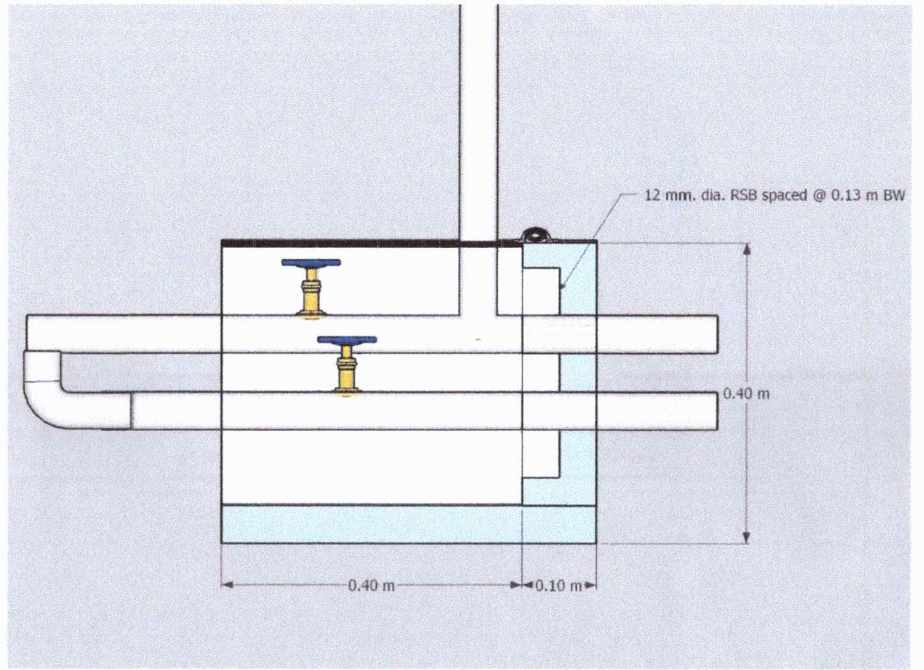
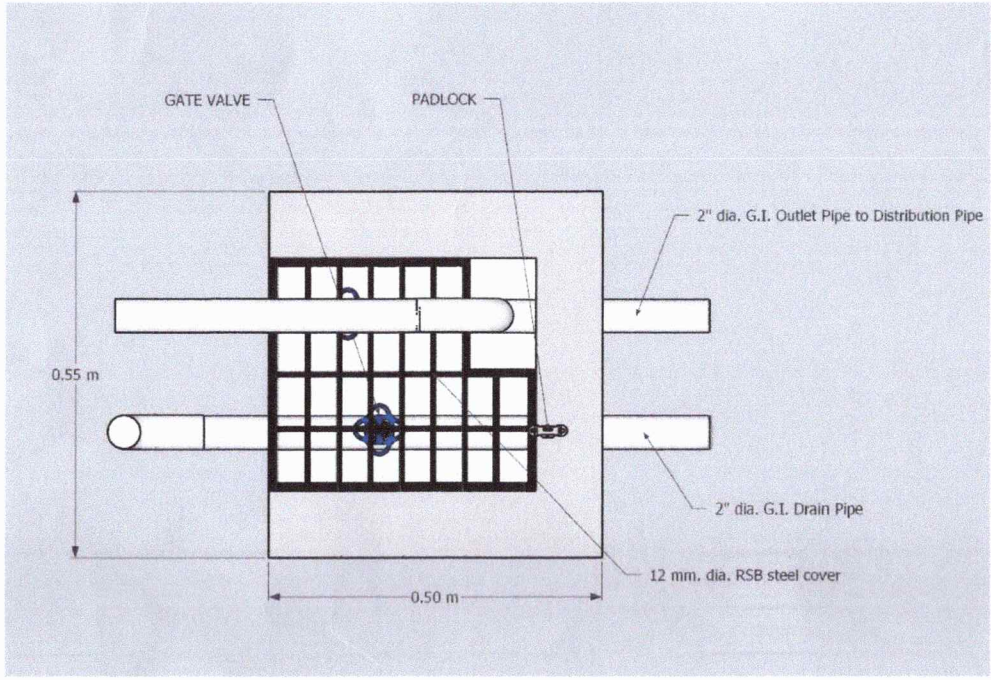

DETAILS OF VALVE BOX



Prepared by:
NELCHELLE ANNE DE GUZMAN
 ENGINEER II

TITLE
**PROPOSED SMALL WATER IMPOUNDING SYSTEM (SWIS)
 (CONCRETE WATER TANK)
 BRGY. BANGA, TINAMBAC, CAMARINES SUR**

VOLUME
13 CUBIC METER

RECOMMENDING APPROVAL BY:
ALEJANDRO D. MARANAN
 OIC, TSD Chief

APPROVED BY:
RONNEL B. ASTOR
 PENR OFFICER

SHEET NO.
 4 / 4

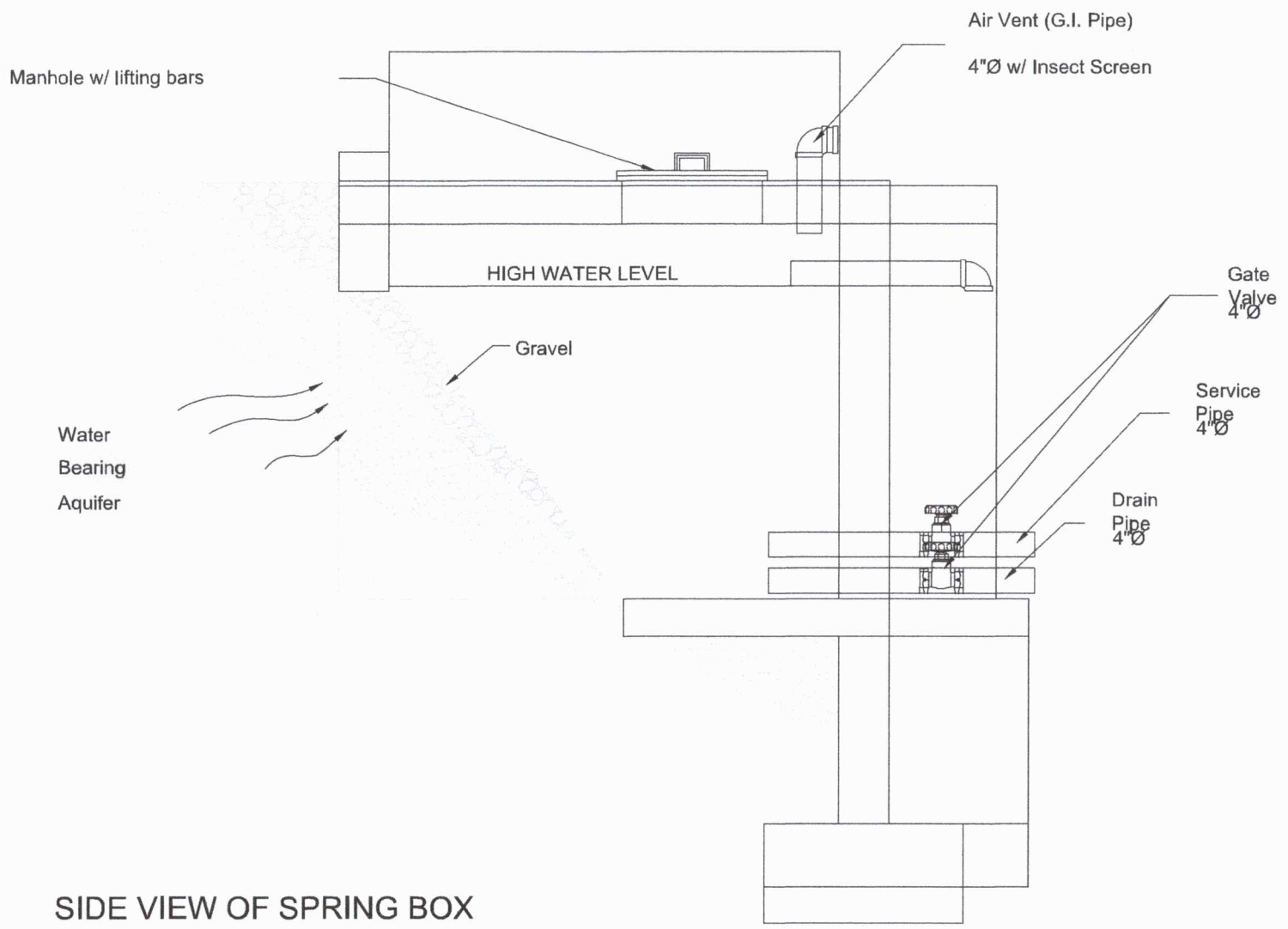

SIDE VIEW OF SPRING BOX

	Prepared by: <i>N.A. Guzman</i> NELCHELLE ANNE DE GUZMAN ENGINEER II	TITLE PROPOSED SMALL WATER IMPOUNDING SYSTEM (SWIS) BRGY. BANGA, TINAMBAC, CAMARINES SUR	VOLUME 13 CUBIC METER	RECOMMENDING APPROVAL BY: <i>A.D. Maranan</i> ALEJANDRO D. MARANAN <small>OFF. CHIEF, TECHNICAL SERVICES DIVISION</small>	APPROVED BY: <i>R.B. Astor</i> RONNEL B. ASTOR <small>PENR OFFICER</small>	SHEET NO. <div style="border: 1px solid black; border-radius: 50%; width: 30px; height: 30px; display: flex; flex-direction: column; align-items: center; justify-content: center;"> 1 2 </div>
--	---	--	---------------------------------	---	--	--

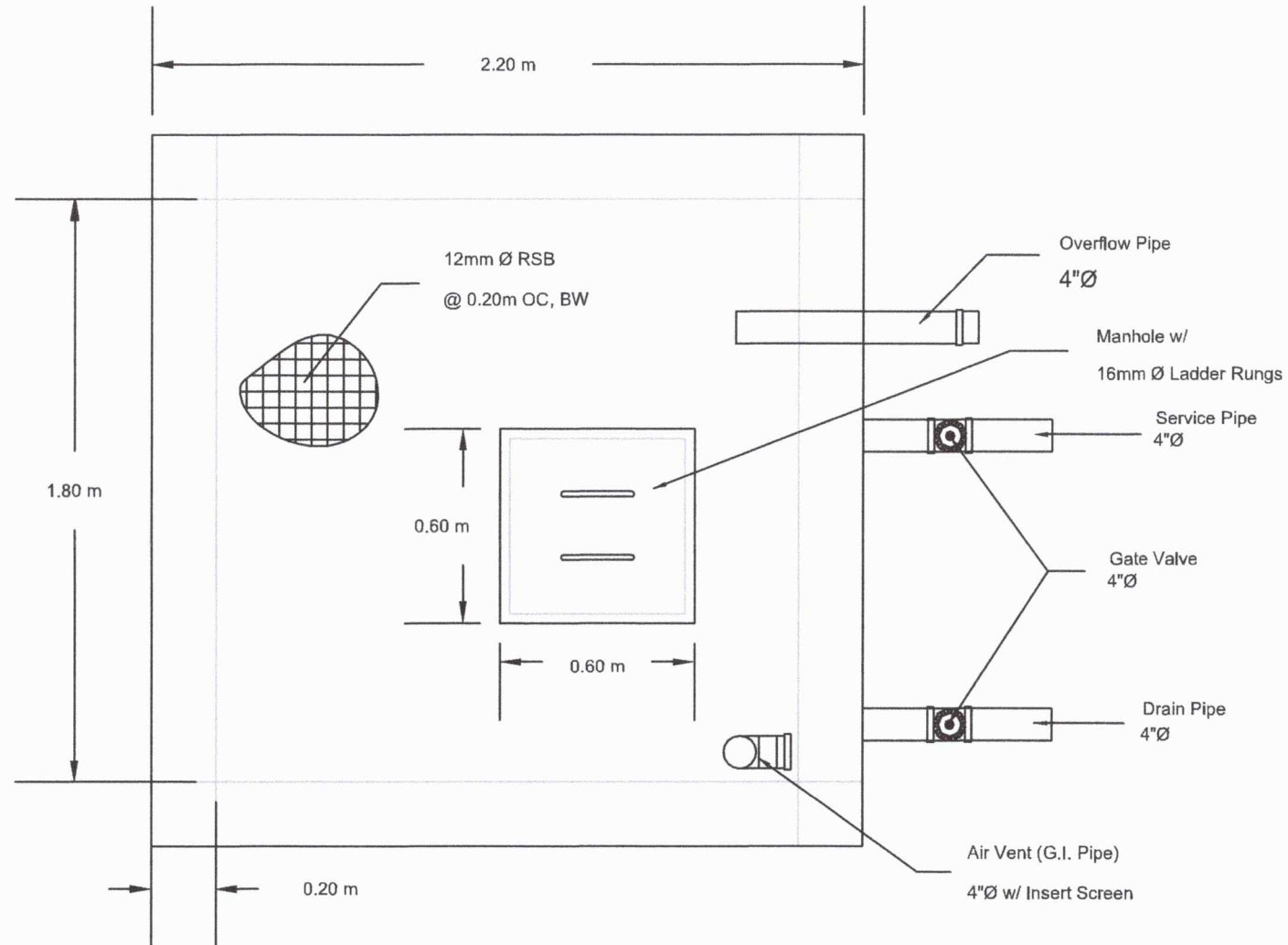

TOP VIEW OF SPRING BOX

	Prepared by: NELCHELLE ANNE DE GUZMAN ENGINEER II	TITLE PROPOSED SMALL WATER IMPOUNDING SYSTEM (SWIS) BRGY. BANGA, TINAMBAC, CAMARINES SUR	VOLUME 13 CUBIC METER	RECOMMENDING APPROVAL BY: ALEJANDRO D. MARANAN OIC CHIEF, TECHNICAL SERVICES DIVISION	APPROVED BY: RONNEL B. ASTOR PENR OFFICER	SHEET NO. <div style="border: 1px solid black; border-radius: 50%; width: 30px; height: 30px; display: flex; align-items: center; justify-content: center;"> 2 2 </div>
--	--	--	---------------------------------	--	--	--

PROGRAM OF WORKS

GENERAL INFORMATION

Name of Project : SWIS-Spring Development Project
 Description : Construction of Spring Box and Storage Tank
 Location : Banga, Tinambac, Camarines Sur
 Discharge from Spring : 5 liters per second
 Storage Tank Capacity : 13 cu.m. of water

Item No.	Description	%	Unit	Qty	Unit Cost	Total Amount
I	Excavation	2.12%	cu.m.	30	630.00	18,900.00
II	Backfill	2.12%	cu.m.	15	1,260.00	18,900.00
III	Installation of Delivery Pipe	16.29%	L.M.	180	807.28	145,310.00
IV	Construction of Spring Box and Storage Tank	64.91%	Lot	1	579,196.00	579,196.00
V	Installation of Distribution Pipes	14.56%	Lot	1	129,936.00	129,936.00
		100.00%			TOTAL	892,242.00

BREAKDOWN OF ITEMS

Total Project Cost	Amount	Percentage
1. Material	648,892.00	68%
2. Hauling of Materials	60,008.00	6%
3. Labor	243,350.00	26%
TOTAL	952,250.00	100%

Total Project Cost say 952,250.00
 PROJECT COST PER CU.M. STORAGE CAPACITY 73,250.00

Prepared by:

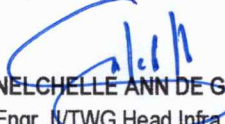
 NELCHELLE ANN DE GUZMAN
 Engr. N/TWG Head Infra

Recommended by:

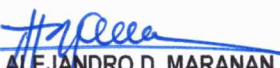
 ALEJANDRO D. MARANAN
 OIC TSD

Approved:

 RONNEL B. ASTOR
 PENR Officer

SPRING DEVELOPMENT PROJECT

Bill of Materials and Detailed Cost Estimates

Item No. I - EXCAVATION

Est. Quantity

30 Cu.m. ✓

LABOR

Manpower Description	Quantity	Duration	Rate/Day	Amount
Foreman	1	7	600.00	4,200.00
Common Laborer	6	7	350.00	14,700.00
Sub-Total				18,900.00

Total Cost of Item		18,900.00
Unit Cost	P/Cu.m.	630

Item No. II - BACKFILL

Est. Quantity

15 Cu.m.

LABOR

Manpower Description	Quantity	Duration	Rate/Day	Amount
Foreman	1	7	600.00	4,200.00
Common Laborer	6	7	350.00	14,700.00
Sub-Total				18,900.00

Total Cost of Item		18,900.00
Unit Cost	P/Cu.m.	1260

**Item No. III - INSTALLATION OF DELIVERY PIPE FROM
SPRING BOX TO STORAGE TANK**

Est. Quantity

180 L.M.

1. MATERIALS

Materials Description	Quantity	Unit	Unit Cost	Amount
Teflon® Tape (1"x390) (US Brand)	7	pc	80.00	560.00
HDPE Pipe 2 1/2" dia SDR 11	180	L.M.	575.00	103,500.00
Compression Coupling 2 1/2" dia	3	pc	1,600.00	4,800.00
Sub-Total				108,860.00

2. LABOR

Manpower Description	Quantity	Duration	Rate/Day	Amount
Foreman	1	9	600.00	5,400.00
Skilled	2	9	500.00	9,000.00
Laborer/Helper	7	9	350.00	22,050.00
Sub-Total				36,450.00

Total Cost of Item		145,310.00
Unit Cost	P/L.M.	807.28

SPRING DEVELOPMENT PROJECT

Bill of Materials and Detailed Cost Estimates

Item No. IV - CONSTRUCTION OF SPRING BOX AND STORAGE TANK (2.20m x 2.20mx2.70m, inside dimension)

1 LOT

1. MATERIALS

Materials Description	Quantity	Unit	Unit Cost	Amount
Portland Cement	300	bag	359.00	107,700.00
Sand Sreened	22	cu.m.	1,272.00	27,984.00
Gravel 3/4	32	cu.m.	1,540.00	49,280.00
16 mm dia. X 6.0 m Rebars	69	pc	446.00	30,774.00
12 mm dia. X 6.0 m Rebars	244	pc	282.00	68,808.00
10 mm dia. X 6.0 m Rebars	70	pc	223.00	15,610.00
Tie wire gauge #16	38	kg	103.00	3,914.00
Sahara	129	pack	58.00	7,482.00
Gate Valve (brazz) 2" dia sched 40	15	pc	3,226.00	48,390.00
G.I. Elbow 90° 2" dia sched 40	18	pc	262.00	4,716.00
G.I Pipe schedule 40 2" dia	6	pc	3,519.00	21,114.00
2"Ø Universal Transition Fitting/Joiner	6	pc	628.00	3,768.00
2"Ø - 1"Ø Universal Transition Fitting/Joiner	3	pc	426.00	1,278.00
2"Ø GI Tee	3	pc	426.00	1,278.00
Forms and Scaffolding	1	lot	45,000.00	45,000.00
Sub-Total				437,096.00

2. LABOR

Manpower Description	Quantity	Duration	Rate/Day	Amount
Foreman	1	29	600.00	17,400.00
Skilled Worker	3	29	500.00	43,500.00
Laborer	8	29	350.00	81,200.00
Sub-Total				142,100.00

Total Cost of Item		579,196.00
Unit Cost	P/Lot	579,196.00

Item No. V - INSTALLATION OF DISTRIBUTION LINES

1 Lot

1. MATERIALS

Manpower Description	Quantity	Unit	Unit Cost	Amount
PE Pipes 2" dia (60 m) SDR 17	10	pcs	9,652.00	96,520.00
Compression Coupling 2" dia	10	pcs	590.00	5,900.00
Teflone Tape (1"x390") (US Brand)	6	pcs	86.00	516.00
Sub-Total				102,936.00

2. LABOR

Manpower Description	Quantity	Duration	Rate/Day	Amount
Foreman	1	9	600.00	5,400.00
Skilled Worker	2	9	500.00	9,000.00
Laborer	4	9	350.00	12,600.00
Sub-Total				27,000.00

Total Cost of Item		129,936.00
Unit Cost	P/Lot	129,936.00